

**TECNA, THE MOST EFFICIENT
AND RELIABLE, LOYAL AND
SECURE PARTNER FOR THE
LOGISTICS AND MAINTENANCE
OF YOUR COMPANY**



RANGE TA

TECNA
2000

Tractor

Four wheels, two front AC drive motor, 48 V., with TECNA technology.

TA 7

TA 10

TA 15





ALL TECHNOLOGICAL ADVANCES OF TECNA CONCENTRATED IN THIS NEW SERIES

The last concept in simplicity, user friendly and pulling power of 2.000 Nw (TA7), 2.800 Nw (TA10) and 4.000 Nw (TA15)

Modern tractor: The last electronic technology. It is able to pull charges of 15.000 Kg.

AC Drive bi-motor: Bigger yield and autonomy.

Ergonomic operator compartment: accesible and antislip floor. Seat weight adjustment.

Roof protector.

Anti turning curves system.

Final solution to pull charges with turning radius in order to work in reduced areas.

Automatic system permits to approach the tractor to the charge.

Two AC traction motors with TECNA technology.



Security

Operation control system for speed reduction at curves (Anti turning)

System for speed reduction control in determined areas (High Security). (optional).



TA 7

Load Capacity

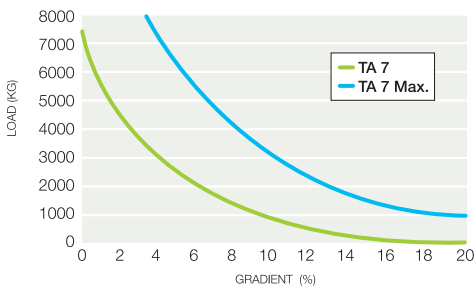

Speed towing power relation

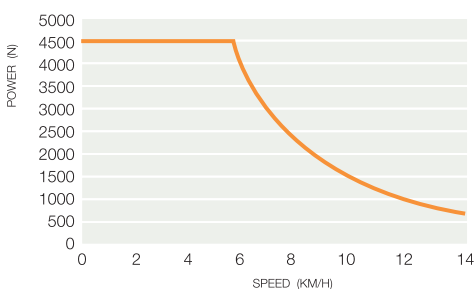

TA 10

Load Capacity

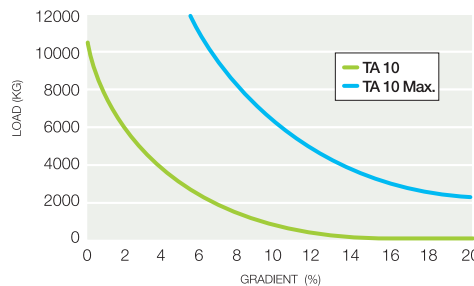

Speed towing power relation

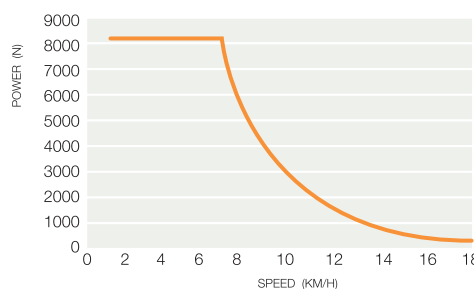

TA 15

Load Capacity

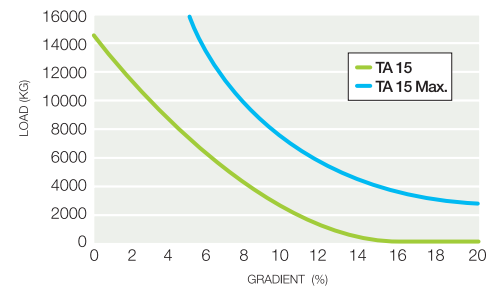

Speed towing power relation

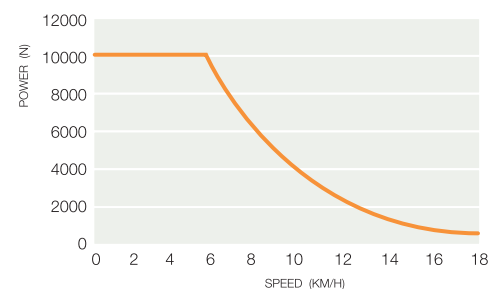

TECHNICAL SPECIFICATIONS ACCORDING TO VDI 2198

Distinguishing mark	1.1	Manufacturer (Abbreviation)			TECNA	
	1.2	Model: Manufacturer's designation		TA7	TA10	TA15
	1.3	Drive: Electric, Battery, Diesel, Petrol, Fuel gas			Battery	
	1.4	Operator position: Hand, Pedestrian, Standing, Seated			Seated	
	1.5	Load capacity/Rated load	Q (t)	----	----	----
	1.7	Rated drawbar pull	F (N)	1400	2000	3000
	1.9	Wheelbase	y (mm)	1040	1360	1360
Weight	2.1	Service weight	kg	1235	2030	2320
	2.2	Axle loading, laden front/rear	kg	----	----	----
	2.3	Axle loading, unladen front/rear	kg	660/575	930/1100	1110/1210
Tyres, Chassis	3.1	Tyres: SE=Superelastic, N=Pneumatic			SE	
	3.2	Tyre size, front		4.00-4	4.00-8	16X6-8
	3.3	Tyre size, rear		18x7-8	6.00-9	21x8-9
	3.5	Wheels number front/rear (x=driven wheels)			2/2X	
	3.6	Tread, front	b10 (mm)	146	820	822
	3.7	Tread, rear	b11 (mm)	790	900	940
	Dimensions	4.7	Height of overhead guard (cabin)	h6 (mm)	1970	1990
4.8		Seat height	h7 (mm)	830	930	930
4.12		Coupling height	h10 (mm)	277/332	305/360	305/360
4.13		Load height, unladen	h11 (mm)	----	----	----
4.16		Length of loading surface	l3 (mm)	----	----	----
4.17		Overhang	l5 (mm)	315	370	370
4.18		Width of loading surface	b9 (mm)	----	1030	1030
4.19		Overall length	l1 (mm)	1730	2110	2110
4.21		Overall width	b1 (mm)	970	1130	1130
4.32		Ground clearance, centre of wheelbase	m2 (mm)	100	100	100
4.35	Turning radius	Wa (mm)	1624	2200	2200	
4.36	Internal turning radius	b13 (mm)	485	950	950	
Performances	5.1	Travel speed, laden/unladen	km/h	8/14	11/18	9/18
	5.5	Drawbar pull, laden/unladen	N	----/1400	----/2000	----/3000
	5.6	Max. Drawbar pull, laden/unladen	N	----/4500	----/6500	----/8500
	5.7	Gradeability, laden/unladen	%	Consult		
	5.8	Max. gradeability, laden/unladen	%	Consult		
	5.10	Service brake		Hydraulic/Electric		
Electric Motor	6.1	Drive motor rating S2 60 min	kW	2x2,5	2x4	2x4
	6.3	Battery acc. to DIN 43531/35/36 A,B,C, no		no	43536 A	43536 A
	6.4	Battery voltage, nominal capacity K5	V/Ah	48/270	80/360	80/500
	6.5	Battery weight	kg	502	965	1210
	6.6	Energy consumption acc. To VDI cycle	kWh/h	----	----	----
	Addition data	8.1	Type of drive control		AC/Inverter	
8.4		Sound level at the driver's ear acc. To DIN 12 053	dB (A)	----	----	----
8.5		Towing coupling, type DIN		Pin		

TECNA products and Specifications are submitted to modifications without previous notification.

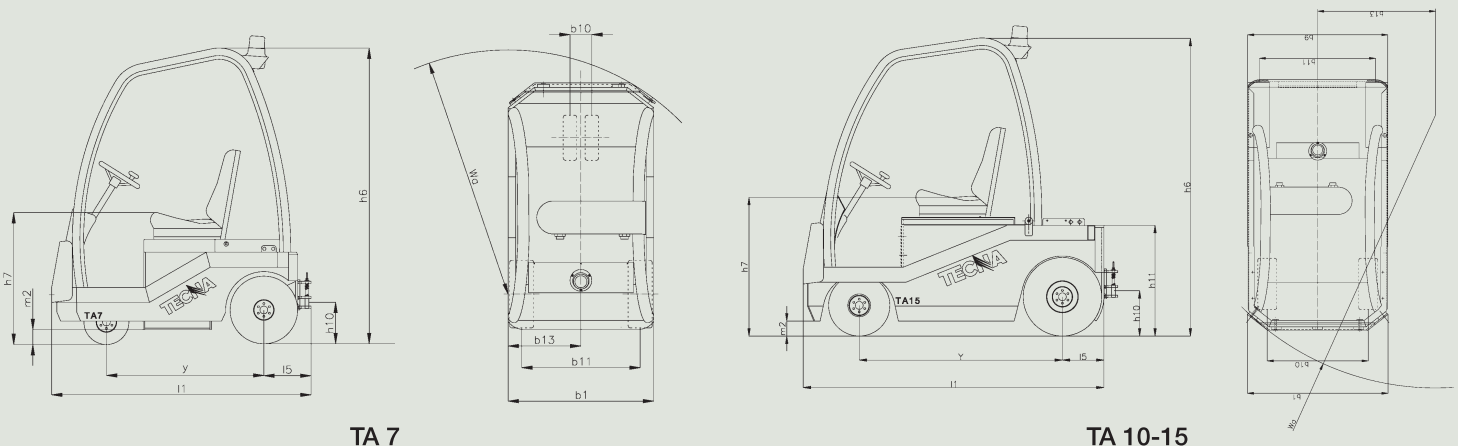



MOD. TA7
Capacity: 7.000 Kg



MOD. TA10
Capacity: 10.000 Kg



MOD. TA15
Capacity: 15.000 Kg

Final solution to pull charges



TECNA 2000

Official distributor:

Pol. Ind. Arazuri-Orcoyen, Calle C 5-7 Str.
31170 ARAZURI (Navarra)
Tel.: 948 324 660
Fax: 948 324 404
E-mail: tecna2000@tecna2000.com
www.tecna2000.com



TECNA 2000 possesses certificates for legal audits under the system for labour safety carried out by A.S.G. (Audit Management Systems).